

INSTALLATION GUIDE

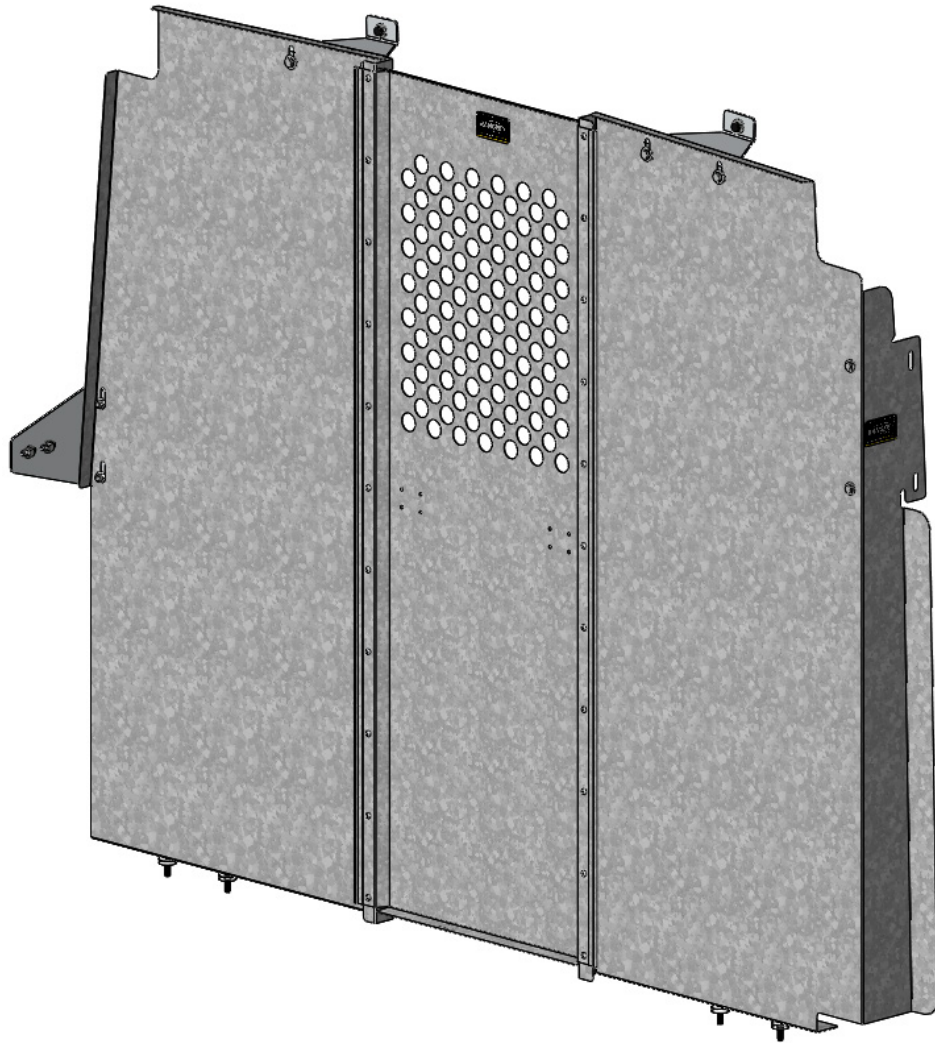

C20-NL STRAIGHT PARTITION

Nissan NV (Perforated Window, No Access, Steel)

QUICK START GUIDE

Phase 1 - Assembly

- 1.1 Setup..... 3
 - 1.1.1 Unpack components; compare with the bill of materials..... 3
 - 1.1.2 Verify all parts are present..... 3
 - 1.1.3 Identify the assembly and installation fastener bags..... 4
- 1.2 Partition assembly..... 5
 - 1.2.1 Remove all the PVC from all the parts, then attach the driver side wing to the driver side panel..... 5
 - 1.2.2 Attach the door panel to the side panels..... 5

Phase 2 - Installation

- 2.1 Tips on how to attach a plusnut..... 6
 - 2.1.1 Attach plusnut using plusnut gun..... 6
 - 2.1.2 Attach plusnut using Ranger plusnut tool..... 6
- 2.2 Vehicle preparation..... 7
 - 2.2.1 Remove the grab handle and the 2 D-rings in the van..... 7
- 2.3 Straight partition installation..... 8
 - 2.3.1 Attach the 2 ceiling brackets in the van..... 8
 - 2.3.2 Lift the assembled partition into the van, then attach plusnuts for the driver side wing..... 9
 - 2.3.3 Attach the driver side wing in the van, then attach the driver and passenger side panels to the ceiling brackets..... 10
 - 2.3.4 Bolt the side panels to the floor of the van..... 11
 - 2.3.5 Attach the passenger side panel to the van..... 12
 - 2.3.6 Apply the warning label on the passenger side panel and re-install the grab handle..... 13

REQUIRED ITEMS

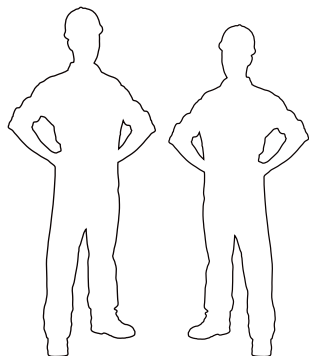

**2
PERSONS**

- Cordless Impact
- Cordless Drill
- Marker
- Plusnut Tool
- Rivet Gun
- Tape Measure
- 3/8" Drill Bit
- 7/16" Socket
- 1/2" Socket
- 9/16" Wrench
- 13mm Socket

PHASE 1 – ASSEMBLY

1.1 SETUP

1.1.1 Unpack components; compare with the bill of materials.

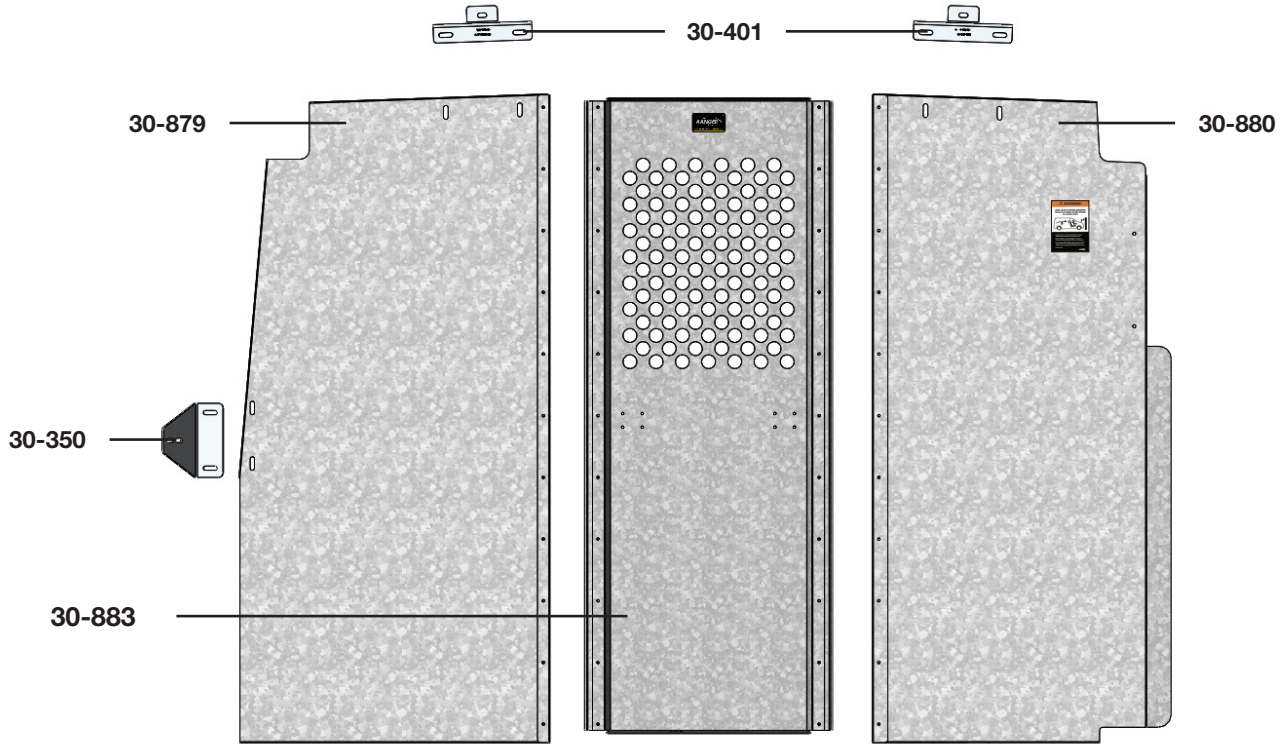

1.1.2 Verify all parts are present.





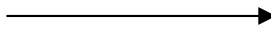

Item No.	Description	Qty.
30-350	Driver Side Wing	1
30-401	Ceiling Bracket	2
30-879	Driver Panel	1
30-880	Passenger Panel	1
30-883	Door Panel	1
79-932	Warning Label (Bilingual)	1
94-3052	Assembly Fastener Bag	1
96-3024	Installation Fastener Bag	1

1.1.3 Identify the 94-3052 and 96-3024 fastener bags.



94-3052 Fastener Bag





Hardware Assembly

2x		# 90-108	Hex Bolt 1/4"-20 x 5/8" ZINC
6x		# 90-204	Hex Bolt 5/16"-18 x 3/4" ZINC
2x		# 94-112	Serrated Nut 1/4"-20 ZINC
6x		# 94-116	Serrated Nut 5/16"-18 ZINC
2x		# 98-112	Flat Washer 1/4", 3/4" OD ZINC
6x		# 98-116	Flat Washer 5/16", 7/8" OD ZINC
22x		# 96-202	Closed Rivet 3/16" x 1/4"

2x (FOR GRAB HANDLE)

	#90-108 Hex Bolt 1/4" x 5/8"
	#98-112 Flat Washer
	#94-112 Serrated Nut

6x

	#90-204 Hex Bolt 5/16" x 3/4"
	#98-116 Flat Washer
	#94-116 Serrated Nut

22x

	#96-202 Closed Rivet
---	----------------------

96-3024 Fastener Bag

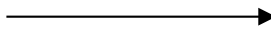



Hardware Assembly

2x		# 90-114	Hex Bolt 1/4"-20 x 1" GR-5 ZINC
2x		# 90-666	Hex Bolt M8-1.25 x 20 CL 8.8 DIN 933 BLACK OXIDE
4x		# 90-668	Hex Bolt M8-1.25 x 40 CL 8.8 DIN 933 BLACK OXIDE
2x		# 94-130	Plusnut .250
2x		# 98-112	Flat Washer 1/4", 3/4" OD ZINC
6x		# 98-116	Flat Washer 5/16", 7/8" OD ZINC
2x		# 98-118	Lock Washer Regular 1/4" ZINC
6x		# 98-122	Lock Washer Regular 5/6" ZINC
8x		# 98-157	Spacer 0.375" ID, x 1.0" OD x 0.25" L NYLON

2x

	#90-114 Hex Bolt 1/4" x 1"
	#98-118 Lock Washer
	#98-112 Flat Washer
	#94-130 Plusnut .250

2x

	#90-666 Hex Bolt M8 x 20
	#98-122 Lock Washer
	#98-116 Flat Washer

4x

	#90-668 Hex Bolt M8 x 40
	#98-122 Lock Washer
	#98-116 Flat Washer
	#98-157 Spacers (2)

PHASE 1 – ASSEMBLY

1.2 PARTITION ASSEMBLY

1.2.1 Remove all the PVC from all the parts, then attach the driver side wing to the driver side panel.

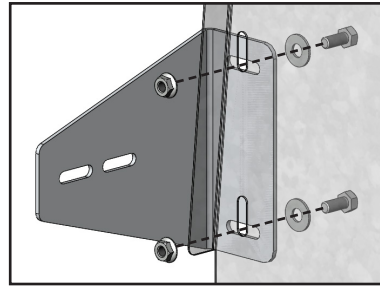
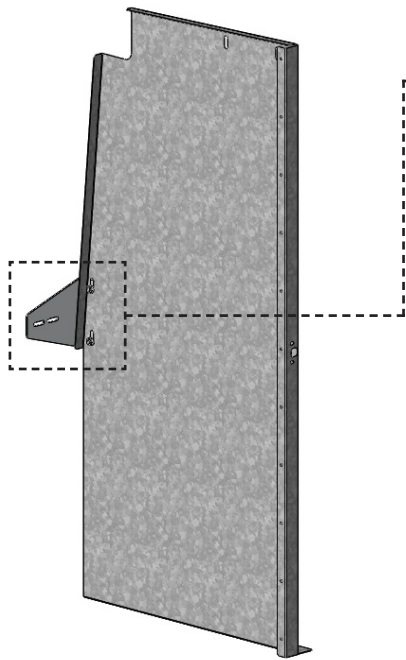



TOOLS

- Cordless Impact
- 1/2" Socket

HARDWARE USED

2x

-  #90-204 Hex Bolt 5/16" x 3/4"
-  #98-116 Flat Washer
-  #94-116 Serrated Nut

1.2.2 Attach the door panel to the side panels.

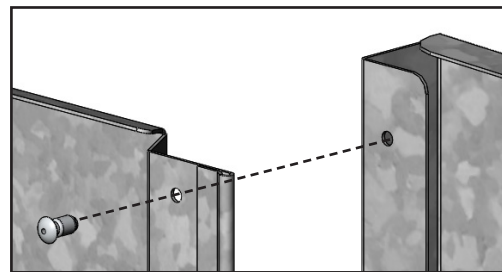
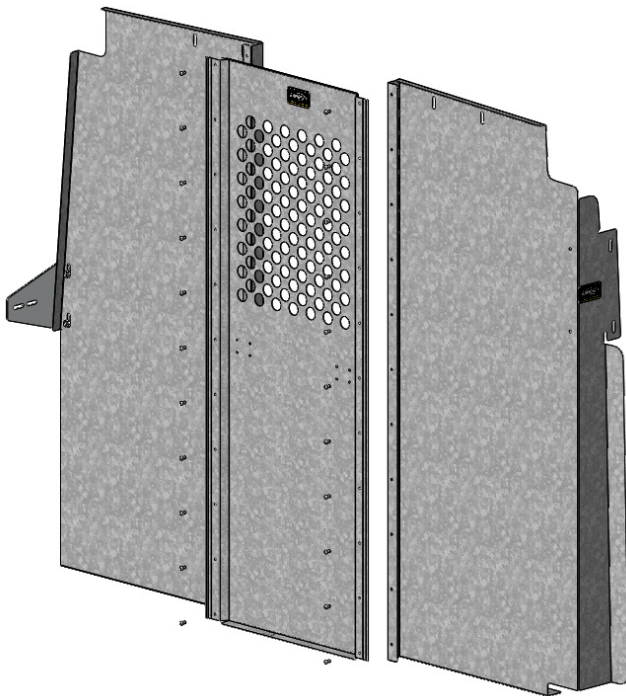

TOOLS

- Rivet Gun

HARDWARE USED

22x

-  #96-202 Closed Rivet

PHASE 2 – INSTALLATION

2.1 TIPS ON HOW TO ATTACH A PLUSNUT

2.1.1 Attach the plusnut using the plusnut gun.

TIPS: Put the plusnut on the plusnut gun, then attach the plusnut in the hole by turning the gun forward until the plusnut locks, then remove the gun by turning in reverse.

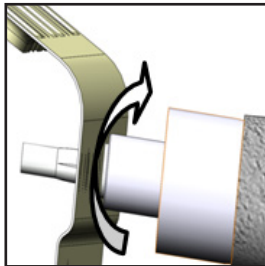

FORWARD

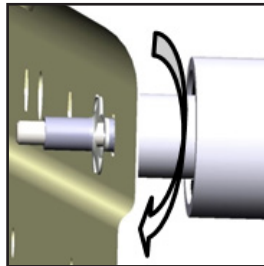

REVERSE

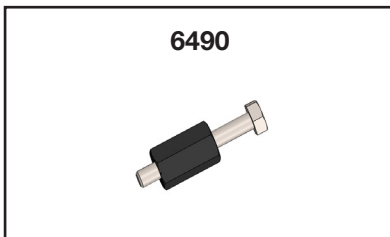

2.1.2 Attach the plusnut using the 6490 plusnut tool.

NOTE: The hardware used for the 6490 plusnut tool is not included in the fastener bag. The 6490 plusnut tool can be ordered separately upon demand at no charge.



6490

HARDWARE USED

-  Flat washer 1/4"
-  Flat washer 1/4" BS x 3/4" OD

- TOOLS**
- Cordless Impact
 - 7/16" Socket
 - 9/16" Wrench

TIPS STEP 1:
Assemble the 6490 plusnut tool with the hardware needed, plusnut and the 9/16" wrench as shown.

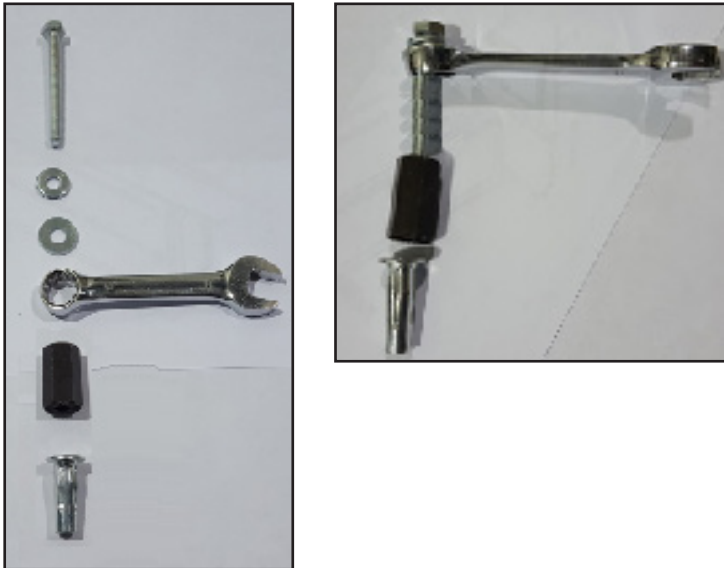

TIPS STEP 2:
Attach the plusnut in the hole by turning the bolt forward using an impact with a 7/16" socket until the plusnut locks, then remove the bolt by turning the impact in reverse.

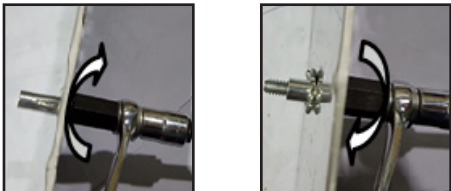

FORWARD **REVERSE**

PHASE 2 – INSTALLATION

2.2 VEHICLE PREPARATION

2.2.1 Remove the grab handle and the 2 D-rings in the van.

NOTE: Keep the grab handle and its hardware for re-use.

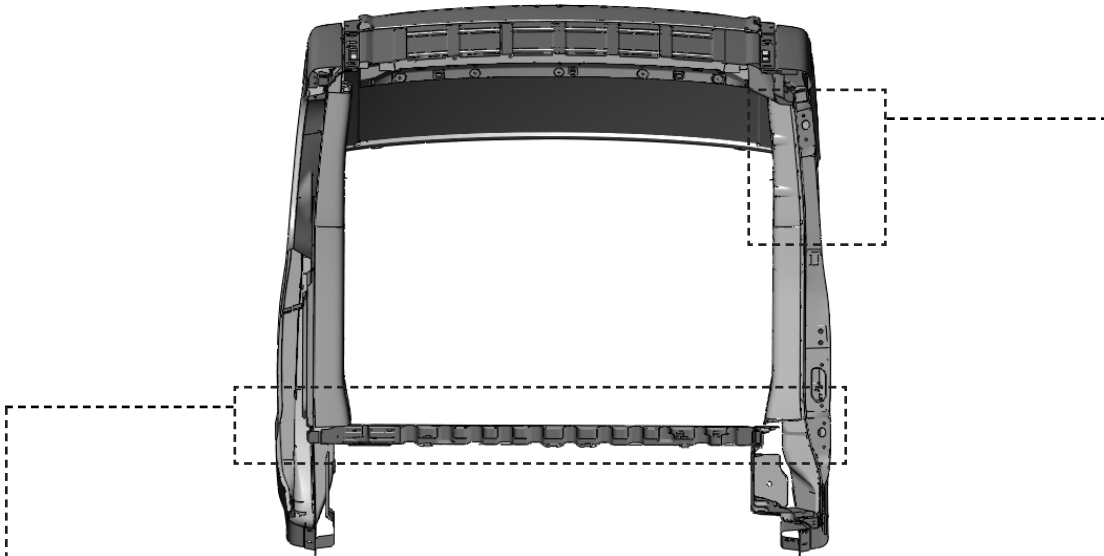

TOOLS

- ❑ Cordless Impact
- ❑ 13mm Socket



TOOLS

- ❑ Cordless Impact
- ❑ 13mm Socket

PHASE 2 – INSTALLATION

2.3 STRAIGHT PARTITION INSTALLATION

2.3.1 Attach the 2 ceiling brackets in the van.

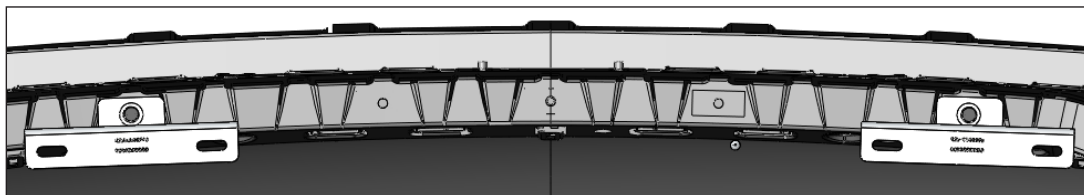
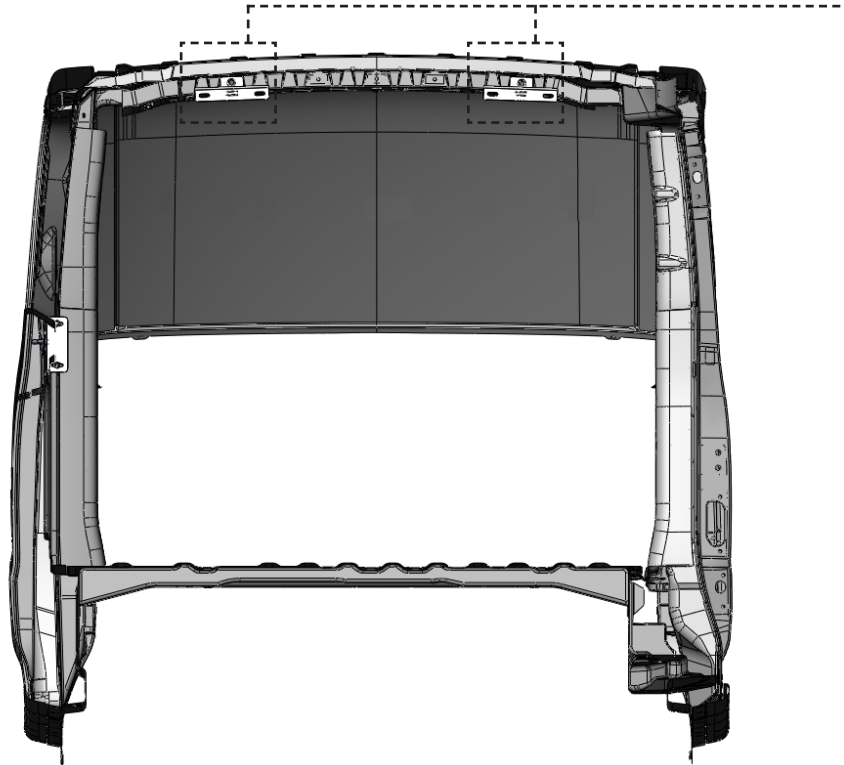

TOOLS

- Cordless Impact
- 13mm Socket

HARDWARE USED

2x



#90-666 Hex Bolt M8 x 20



#98-122 Lock Washer



#98-116 Flat Washer

2.3.2 Lift the assembled partition into the van, then attach plusnuts for the driver side wing.

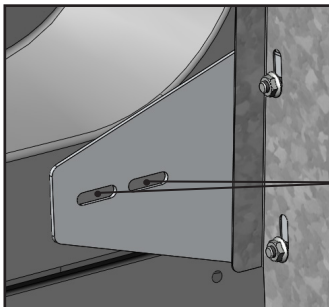
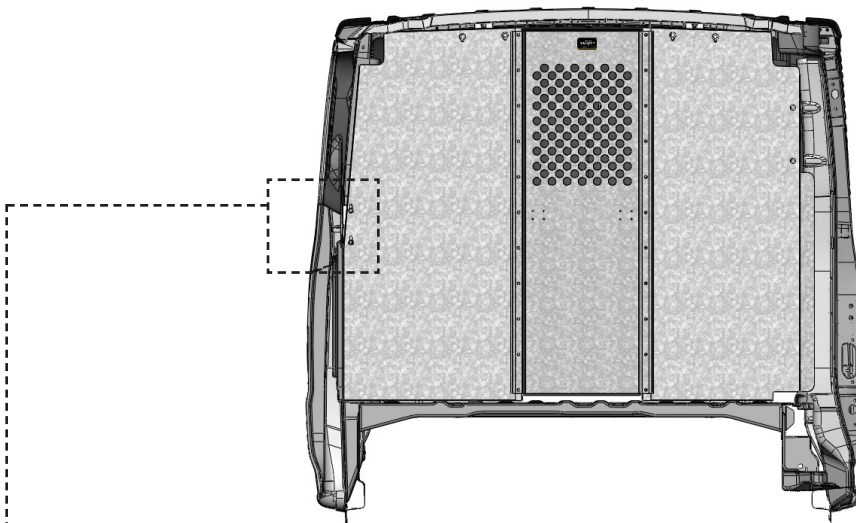

MARKS

Put the driver side panel in place, then place marks through the holes of the driver side wing.

TOOLS

- Marker



Drill the 2 marks using 3/8" drill bit or step drill.

TOOLS

- Cordless Drill
- 3/8" Drill Bit or Step Drill



Attach plusnuts in the 2 holes.

TOOLS

- Plusnut Tool

HARDWARE USED

2x

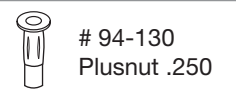

2.3.3 Attach the driver side wing in the van, then attach the driver and passenger side panels to the ceiling brackets.

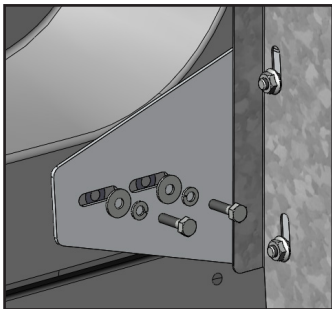
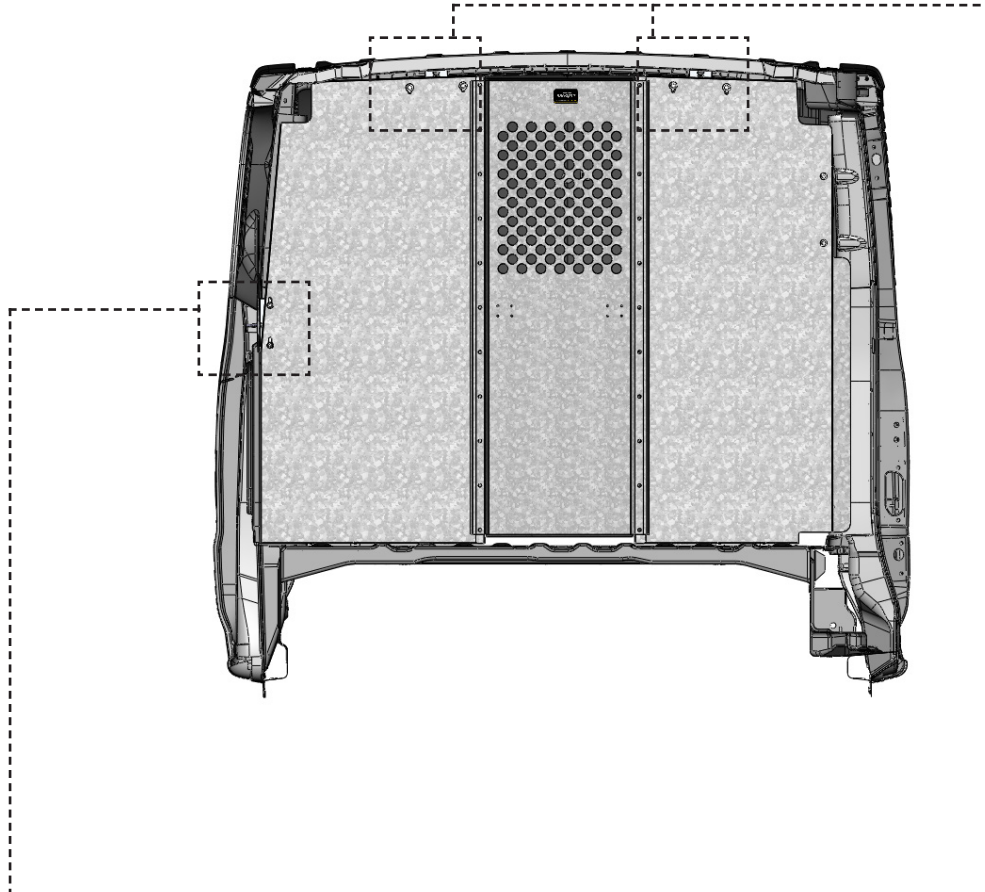

TOOLS

- Cordless Impact
- 7/16" Socket

HARDWARE USED

2x

-  #90-114 Hex Bolt 1/4" x 1"
-  #98-118 Lock Washer
-  #98-112 Flat Washer

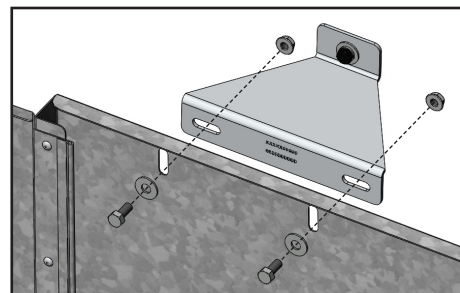



TOOLS

- Cordless Impact
- 1/2" Socket

HARDWARE USED

4x

-  #90-204 Hex Bolt 5/16" x 3/4"
-  #98-116 Flat Washer
-  #94-116 Serrated Nut

2.3.4 Bolt the side panels to the floor of the van.

NOTE: Use spacers to level the floor.

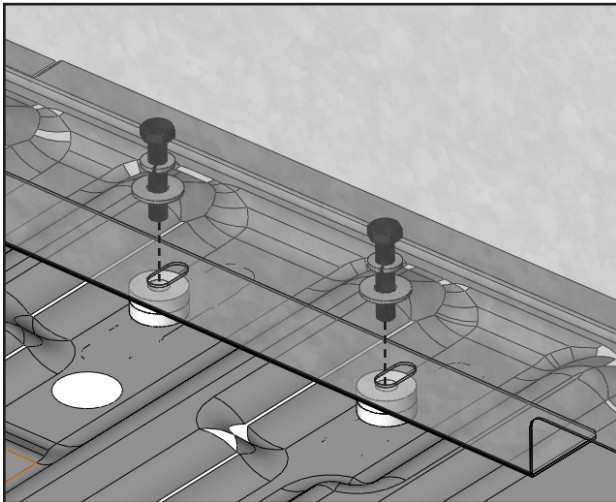
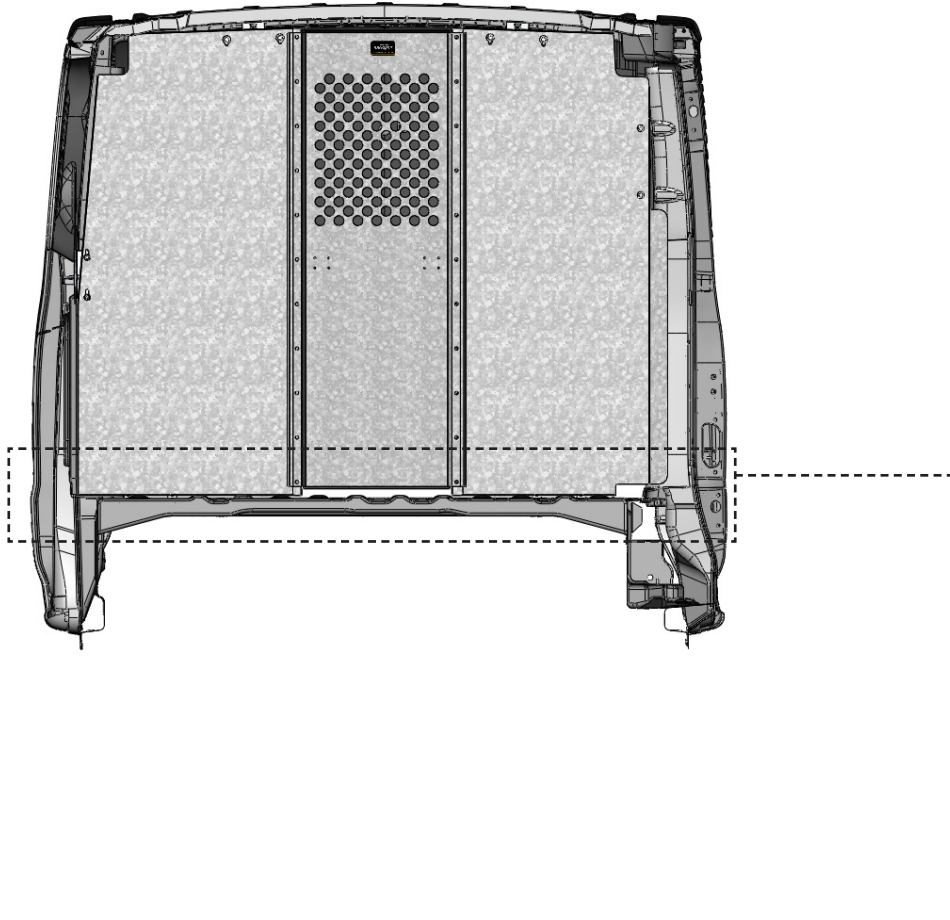





TOOLS

- Cordless Impact
- 13mm Socket

HARDWARE USED

4x

- | | |
|---|--------------------------|
|  | #90-668 Hex Bolt M8 x 40 |
|  | #98-122 Lock Washer |
|  | #98-116 Flat Washer |
|  | #98-157 Spacers (2) |

2.3.5 Attach the passenger side panel to the van.

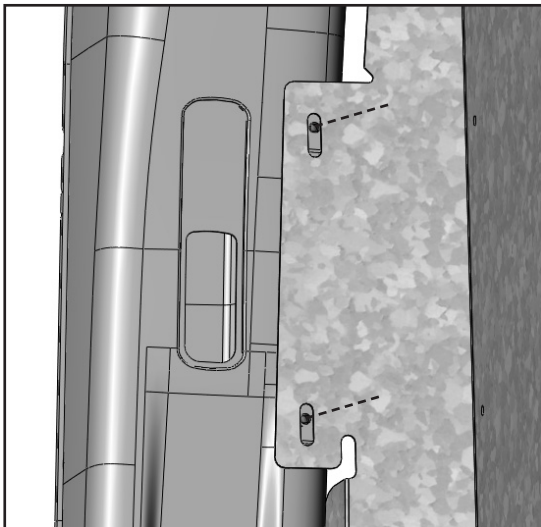
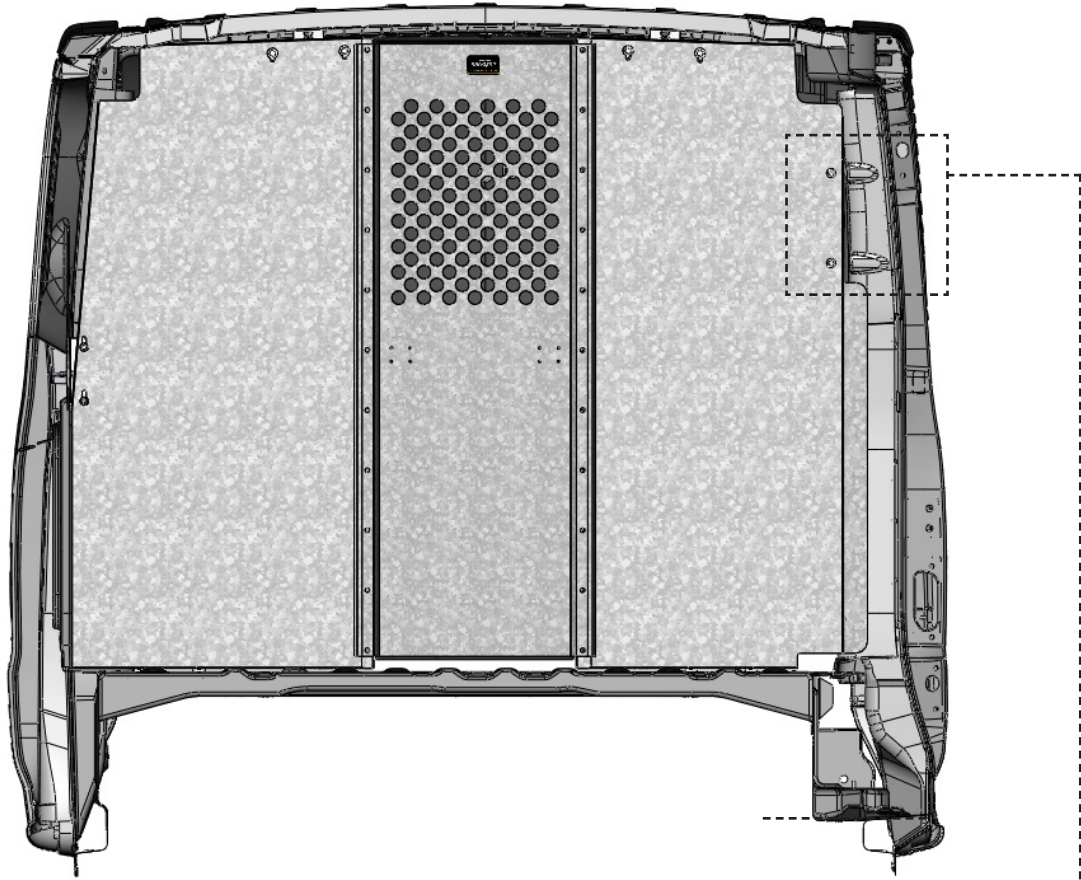

TOOLS

- Cordless Impact
- 13mm Socket

HARDWARE USED

2x

Use the hardware from the grab handle.

2.3.6 Apply the warning label on the passenger side panel and re-install the grab handle.

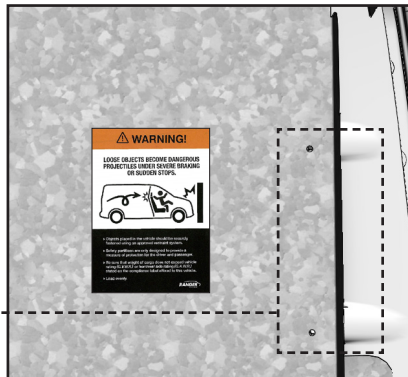
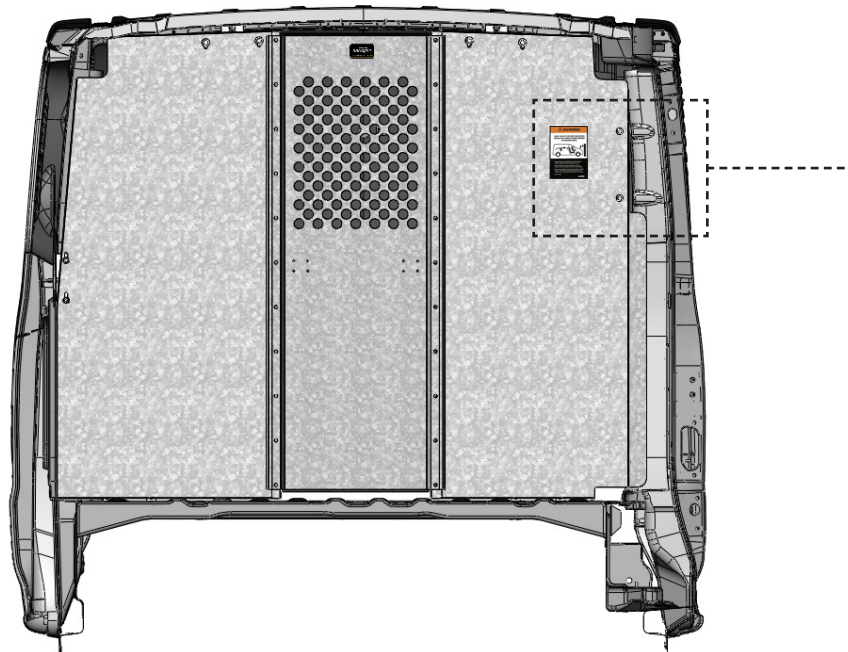

NOTE: English warning label is already attached on the passenger side panel.





TOOLS

- Cordless Impact
- 7/16" Socket

HARDWARE USED

2x

- | | |
|---|------------------------------|
|  | #90-108 Hex Bolt 1/4" x 5/8" |
|  | #98-112 Flat Washer |
|  | #94-112 Serrated Nut |

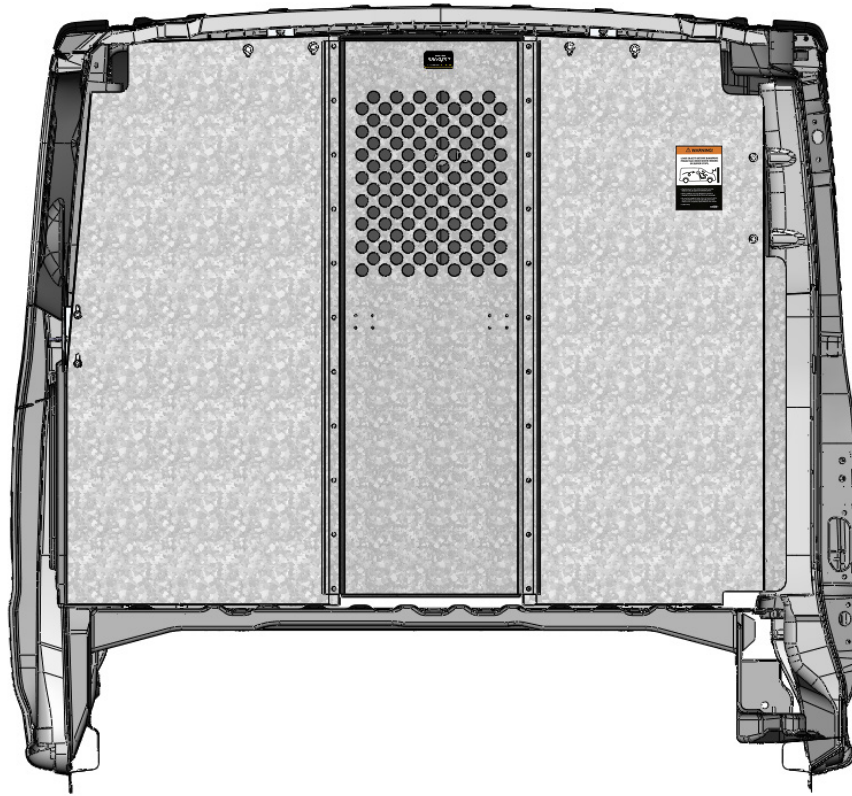

**“Congratulations, you have successfully installed your
Straight Partition!”**

Thank you for doing business with us.”

For any feedback or suggestions you may have, please contact: cs@rangerdesign.com

